

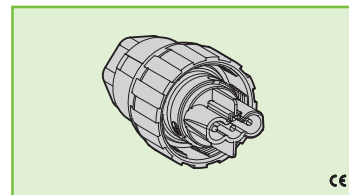

3601/V-GR



SPINA DI CONNESSIONE PROTETTA PROTECTED CONNECTION PLUG

Dati tecnici

Technical data





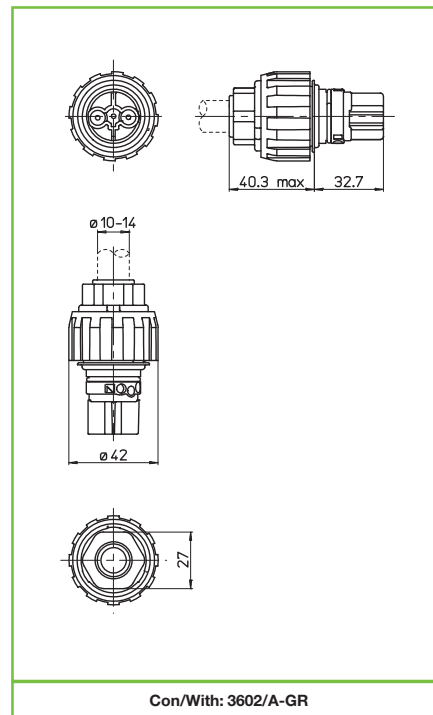

- Poli - Poles	2P+T
- Corrente e tensione nominale - Rated current and voltage	16A-250V
- Temperatura massima di funzionamento (IEC) - Maximum operating temperature (IEC)	T120
- Grado di protezione - Protection index	IP66
- Categoria di sovratensione - Impulse withstand category	III

Caratteristiche





Characteristics

- Corpo in poliammide .../GR= grigio
— Polyamide body .../GR= grey
- Contatti in ottone argentato
— Silver plated brass contacts

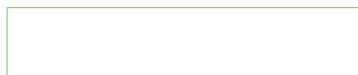

 senza fissaggio without fixing	 spina di connessione connection plug	 serrafilo con vite e morsetto screw terminals	 sezione conduttore flessibile con fascetta section of the flexible conductor with ferrule
 sezione conduttore rigido rigid conductor section	 spelatura cavetti rigidi e flessibili con fascetta rigid and flexible with ferrule wires stripping	 adatto per tensione di accensione ad impulsi fino a... suitable for impulse ignition voltage up to...	 protetto IP66 IP66 protected
			

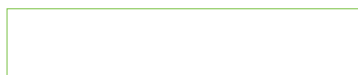

Marchi di qualità Quality marks

Direttive Europee European directives

Conforme "RoHS"
"RoHS" compliant
Non soggetto alla "RAEE"
Not subject to "WEEE"

Pesi e confezioni Weights and packaging

Art. codice prodotti product references	g peso netto net weight	 pezzi per sacco pieces per bag	 pezzi per scatola pieces per box
3601/V-GR	39,5		100

Note Notes