



A.A.G. STUCCHI

Essential for lighting



A.A.G. STUCCHI s.r.l. u.s.
Via IV Novembre 30/32,
23854 Olginate (LC) Italy
Ph. +39 0341 653111
Fax +39 0341 653250
www.aagstucchi.it
info@aagstucchi.it

2122 2122/Q
2122/PA 2122/Q-PA
2122/PC 2122/Q-PC

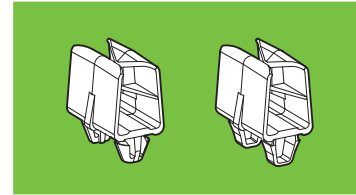

PASSAFILO PER CABLAGGIO AUTOMATICO WIREHOLDERS FOR AUTOMATING WIRING

Caratteristiche Characteristics

in polipropilene
in polypropylene





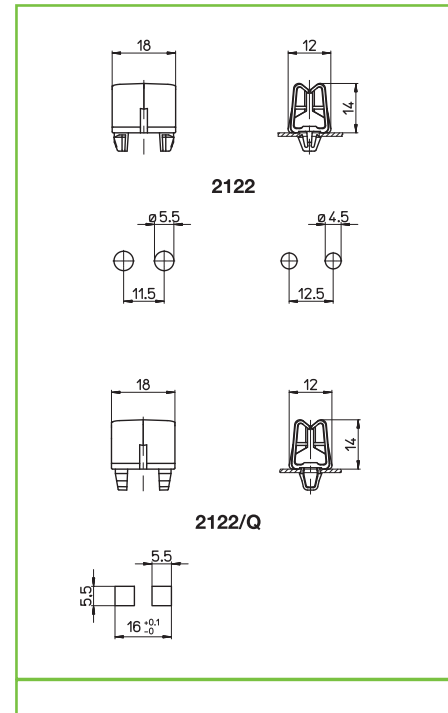



...PA= versione in poliammide
...PA= polyamide version

...PC= versione in policarbonato
...PC= polycarbonate version

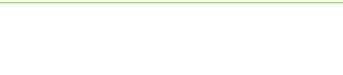

 fissaggio automatico ad innesto push fixing	 spessore lamiera metal plate thickness 0,6-0,9	 IP40 nei punti d'aggancio IP40 in the hooking points	
			
			



Marchi di qualità Quality marks

Direttive Europee European directives

Conforme "RoHS"
"RoHS" compliant
Non soggetto alla "RAEE"
Not subject to "WEEE"

Pesi e confezioni Weights and packaging

Art. codice prodotti product references	g peso netto net weight	 pezzi per sacco pieces per bag	 pezzi per scatola pieces per box
2122	0,8		10000
2122/Q	0,8		10000
2122/PA	1		10000
2122/Q-PA	0,8		10000
2122/PC	1,1		10000
2122/Q-PC	1		10000

Note Notes