



A.A.G. STUCCHI

Essential for lighting



A.A.G. STUCCHI s.r.l. u.s.
 Via IV Novembre 30/32,
 23854 Olginate (LC) Italy
 Ph. +39 0341 653111
 Fax +39 0341 653250
 www.aagstucchi.it
 info@aagstucchi.it

1699/V

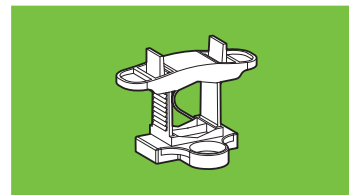







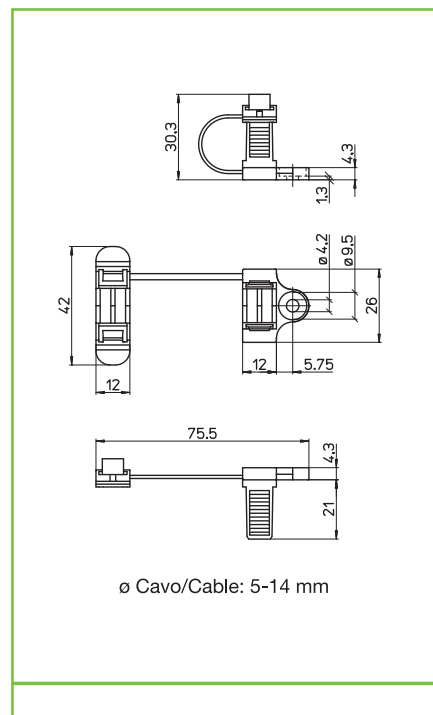





BLOCCCAVAO
CABLE LOCK

Caratteristiche
Characteristics





in poliammide
 in polyamide



 fissaggio con vite
 screw fixing

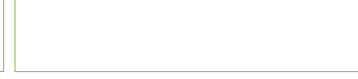

Marchi di qualità
Quality marks

Direttive Europee
European directives

Conforme "RoHS"
 "RoHS" compliant
 Non soggetto alla "RAEE"
 Not subject to "WEEE"

Pesi e confezioni
Weights and packaging

Art. codice prodotti product references	g peso netto net weight	 pezzi per sacco pieces per bag	 pezzi per scatola pieces per box
1699/V	3,1	1000	200

Note
Notes