

285/FD

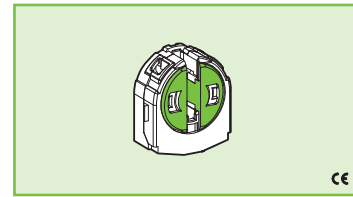

PORTALAMPADE A PASTIGLIA PER LAMPADE FLUORESCENTI LINEARI T5 ROUND LAMPHOLDER FOR T5 FLUORESCENT LINEAR LAMPS









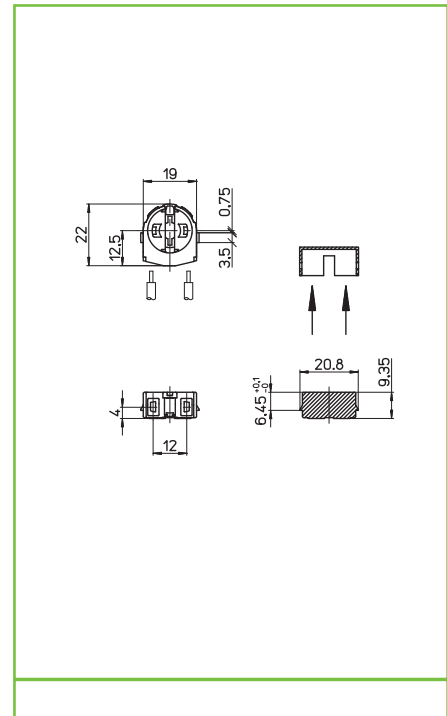

Dati tecnici Technical data

- Attacco lampada - Lamp cap	G5
- Corrente e tensione nominale - Rated current and voltage	2A-500V
- Temperatura massima di funzionamento (IEC) - Maximum operating temperature (IEC)	T130 Tm110
- Grado di protezione - Protection index	IP20
- Categoria di sovratensione - Impulse withstand category	III





Caratteristiche Characteristics

- Corpo in policarbonato
— Polycarbonate body
- Contatti in lega di rame
— Copper alloy contacts



 fissaggio a scatto in testate <i>snap fixing into caps</i>	 spessore portalampade/portastarter <i>lampholders/starterholders thickness</i>	 rotore in PBT verde con scatti di... <i>PBT green rotor with position of...</i>	 serrafilo automatico a 2 fori <i>push-wire terminals with 2 holes</i>
 sezione conduttore rigido <i>rigid conductor section</i>	 spelatura cavetti rigidi <i>rigid wires stripping</i>	 S-285/...	
			



Marchi di qualità Quality marks

Direttive Europee European directives

Conforme "RoHS"
"RoHS" compliant
Non soggetto alla "RAEE"
Not subject to "WEEE"

Pesi e confezioni Weights and packaging

Art. codice prodotti product references	g peso netto net weight	 pezzi per sacco pieces per bag	 pezzi per scatola pieces per box
285/FD	2,7	1000	500

Note Notes